

## Pulled Plug-flow Model for 4<sup>th</sup> Generation District Heating

Lubomir Vasek\*, Viliam Dolinay\*, Vladimír Vasek\*

\* Tomas Bata University in Zlin, Faculty of Applied Informatics, Nad Stranemi 4511, 760 05 Zlin  
Czech Republic (e-mail: [lvasek@utb.cz](mailto:lvasek@utb.cz), [vdolinay@utb.cz](mailto:vdolinay@utb.cz), [vasek@utb.cz](mailto:vasek@utb.cz))

**Abstract:** The controlling of modern district heating systems requires accurate models and simulation tools. The description and necessary verification of a model that sets these ambitions is a matter of this contribution. The model comes out of the known method - plug flow modelling. The implemented model works on the pulling principle when the amount of heat from the producer is “pulled” by the customer. The model was implemented and verified on the data of the local operator of the heating plant and distribution network. The model has been set to the parameters of the part of a real DH network, and its accuracy has been tested about traffic delays and heat loss in the pipelines. For the present experiment, the full knowledge of the heat demand was considered. These were optimal conditions and perhaps not just because of it the result that the pull plug flow model achieved was a quite good matching the measured and calculated values.

© 2019, IFAC (International Federation of Automatic Control) Hosting by Elsevier Ltd. All rights reserved.

**Keywords:** Consumption, district heating, energy, modelling, plug-flow, prosumer.

### 1. INTRODUCTION

This article focuses on the District Heating (DH) systems, which are a very important part of the heat supply to the population concentrated mainly in urban agglomerations. Heating is notably one of the basic life needs in the areas of middle and cold geographic zones. Hence, there is a considerable need to pay attention to these issues, in practical and theoretical terms (Tilia, 2016).

The importance of this issue is also growing in the context of the current energy situation. In most of the developed countries in recent years there has been a significant diversification of the energy resources used in connection with the progressive depletion of classical energy sources and their replacement by new sources, often based on other physical and chemical principles for energy generation - e.g., solar, photovoltaic, wind, geothermal, etc. This often leads to the fact that these new sources have different properties, not only from the point of view of the energy acquisition process but also from the point of view of its distribution - the reducing of the importance of large, central energy sources and, on the contrary, the increase in the influence of the use of smaller, local but interconnected sources (Werner, 2017).

Above mentioned, of course, significantly affects the structure and management of both currently used and newly built DH systems. In order to analyse them and to handle the changes in their operation and use, new and / or modified methods must be developed and used to increase their efficiency and thereby achieve significant energy savings. The present paper describes a method for analysing the events taking place in the DH distribution system. The method is based on the creation and analysis of the mathematical-physical model of the distribution network, and its use is predominantly intended for DH operation control.

#### 1.1 Modelling of the distribution network

The modelling of the distribution network of district heating systems is computationally very demanding. One of the main interests in modelling the heat supply network (or cold) is a simulation of energy transfer through the system (Starkloff et al, 2015). This transfer depends on the flow rate and the water temperature in the network. This flow due to the pressure difference between system input and output is responsible for most of the energy transport. There is, however, a great difference between flow and temperature dynamics. While flow changes are rapidly transmitted in the order of seconds across the network, temperature changes are tied to the flow of water in the pipelines, and so changes in temperature are transmitted significantly slower.

#### 1.2 Plug-flow model

One of the widely used approaches to discrete modelling of media flow in the pipeline system is the plug-flow method. In our case, we are dealing with a hot-water distribution network. The simulation takes place in discrete steps and thus into the piping systems, in the discrete moments enter the quantum (plug) of the size given by the required flow and the discrete step period. If the condition, when the pipelines are filled is met, and the fact that the fluid is incompressible, the entry of a new quantum, or the move of any other quantum (depending on the angle of view), the previous quantum in the pipe is pushed in the direction of flow. If the open system were to be considered, the new quantum that enters the system would push the same volume out of the system.

Plug-flow models have a number of implementations. Our team has been working for years to create such models for district heating. First, we worked with a model whose algorithm might be called “Pushed Plug Strategy”. However, this algorithm had some constraints and was gradually

transformed into the so-called “Pulled Plug Strategy”. Both algorithms are briefly described below.

## 2. PUSHED PLUG STRATEGY

In the traditional and still widespread structure of district heating (at least in the Central European region), there is usually one producer for the whole network (heating plant, cogeneration power plant). When modelling such network by this plug-flow model, the new plug is added to the system, and further wander through the system. The plug is divided when passing nodes and after passing through the consumer, where it is significantly cooled - transmitted the heat. After that, it is pushed back towards the return pipe to the producer (Vasek, Dolinay & Vasek, 2014).

This is one of the possible logical approaches to simulate the process of heat transfer media flows through DH networks. This model was used in two phases.

First, identification was made to recognize coefficients for heat loss in individual consumers or pipelines based on historical data measured in the producer (outlet and inlet water temperature and mass flow). The entire identification process ran iteratively when new coefficients were set for each iteration (simulation attempt for a given time period) and tested for a match with measured data. The result of the simulation experiment was evaluated based on the conformity of the obtained return water temperature course and measured course. Learning (identifying) the model parameters, i.e., determining (searching for) appropriate coefficients, was performed by artificial intelligence methods (Kral et al, 2011).

The identified (learned) model was used, for example, to simulate the behaviour of the system when modifying the input (the behaviour of the system when using another temperature curve during the day) or a prediction variant where the heating requirements were predicted on the basis of meteorological forecasts in a given heating strategy or, alternatively, to seek more appropriate strategies (by modifying the day course of the heating water temperature).

As already pointed, this model has a number of limitations, and the degree of precision has not been enough, especially not for applications in intelligent 4GDH systems (Lund et al, 2014). The main limitation was that the accuracy of the model algorithm depended on the availability and completeness of the data used. In current DH systems, data is usually available for the producer and possibly several reference points of consumption. Newly built 4GDH systems do not suffer from this ailment and offer much more detailed information. With this information, future models should be able to work - they should be able to use them to refine himself.

## 3. PULLED PLUG STRATEGY

Pulled plug strategies can be seen as the second generation of our plug-flow model. It primarily works with much more extensive information and data from the heat distribution

network. Data refinement allows several significant conceptual changes to the model formulation. However, the fundamental principle remains the same - the flow is discriminated into the flow quantum (plugs), their movement allows the distribution of heat. Plugs lose part of their thermal energy during the passage through the system, thereby reducing their temperature, either by losses in the piping system or by cooling more significantly when passing through the consumers.

### 3.1 General plug flow model principles

In each simulation step, indexed  $j$ , each flow quantum, indexed  $i$  and denoted  ${}^jDFQ_i$  in the network is shifted in the direction of flow. Representation of the discrete flow quantum is shown in figure. 1 (Vasek, Dolinay & Vasek, 2014),

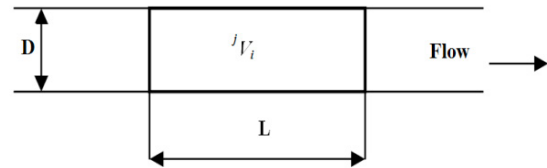

Fig. 1 Discret Flow Quantum  ${}^jDFQ_i$

where:

- $D$ , is pipe diameter in the current  ${}^jDFQ_i$  location,
- $L$ , is the current  ${}^jDFQ_i$  length, and
- ${}^jV_i$  is the  ${}^jDFQ_i$  volume.

#### 3.1.1 Heat transfer modelling

For each flow quantum which is in the distribution network at a given time, its heat balance is calculated in every simulation step. The differential equation describing this step is shown below:

$$\frac{dT}{dt} = K * (T - T_{ext}) \quad (1)$$

where:

- $K$  is the constant describing the thermal characteristics for the particular element of the distribution network and the heating medium,
- $T$  is the current temperature  $DFQ$  in the particular simulation step  $j$ ,
- $T_{ext}$  is the current outside temperature (environment where the tube is mounted).

Resolving Equation (1), leads to obtaining eq. (2):

$$T_1 = \exp(-K*t) * (T_0 - T_{ext}) + T_{ext} \quad (2)$$

Where:

$T_0$  and  $T_1$  are the water temperature at the beginning and end of the time interval  $\Delta t$

The amount of heat  $\Delta Q$ , transferred in a given time interval, is then the function of the heat capacity  $c_p$ , volume  $V$ , density

$\rho$  of the heated water and the temperature difference  $T_0$  and  $T_{\text{ext}}$ , i.e.:

$$\Delta Q = c_p \cdot V \cdot (T_0 - T_{\text{ext}}) \cdot (1 - \exp(-K \cdot \Delta t)) \quad (3)$$

For the more detailed description of the flow quantum model principles see (Vasek, Dolinay & Vasek, 2014).

The differences in pulled plug strategy, which is only a variant of the general model, will be explained in chapter 3.4 Algorithm.

### 3.2 Active elements in the model

The first of the conceptual changes, according to the previous version of the model, is that the objects are not divided into the producers and the consumers. The prosumer concept (Vasek & Dolinay, 2017) has been implemented in the model, so each of the objects can be a producer or consumer. One object cannot be a consumer and a producer at the same time. For example, a producer with its own consumption is still seen from an outside view as a producer, just the heat it offers to others is reduced by its own consumption. On the contrary, a consumer, typically an active building at a particular time of day/year can offer its surpluses and act as a producer and another time when it is lacking becomes a consumer. See passive houses (Bulut et al, 2016). Therefore, the model works only with one type of active element - prosumer.

The second change or extension of the previous concept is a deeper integration of the holonic approach, i.e., all elements are modelled as autonomous and mutually cooperating. For more details, see (Vasek & Dolinay, 2015)

In general, this can be summarized as intelligence and "decision-making" power can be distributed to individual prosumers or their groups. A typical example could be the situation where, for a large cogeneration source, with a view to a short-term decline or an increase in demand for electricity, the production of the usual amount of heat becomes economically less advantageous. At this point, however, it may be advantageous to engage or modify the performance of other producers (prosumers) and thereby increase / decrease their share in total output. Accumulating systems may also be involved (charging or discharging – a typical example of the prosumer definition), but also classic building consumers can join. If the group of houses gives up (for a few hours) their demand for heat or vice versa for a certain period of time, it will take a little more it will not cause them any inconvenience - the reduction of the heating performance by several tens of percent for several hours in a modern, well-isolated buildings means the temperature drops to a maximum of a tenth of a degree of Celsius. This small hit for a single consumer, when multiplied by the number of objects involved (housing estates, etc.), gives the producers a great deal of space for optimizing their operation. The possibility to implement and simulate such cooperation is given by the incorporation of the principles of distributed control, in our case based on the consistent application of holonic principles (Vasek & Dolinay, 2017).

### 3.3 Passive elements in the model

Other elements of the model are already remaining the same as they were in the first version of the model. These are pipesections - encapsulating pipelines and netnodes, providing branching or merging piping systems.

- The pipesection has a defined one input and one output point. This point may be a prosumer or a netnode. Each pipesection must contain at least one pipeline.
- The pipeline element includes the physical properties of the network. Each pipeline must have a defined diameter and length. In addition, the heat loss coefficient (not only the material constant of the pipe, but the general parameter including the properties of the pipe (material, insulation), and also type of its installation (above / below the ground, etc.) This coefficient is identified on the basis of the measured data. To better visualize the network model, each pipeline can also have a defined geographical location of its origin.
- Netnode is defined by its inputs and outputs (pipesections). Every Netnode must have at least one input and one output.

### 3.4 Algorithm

The algorithm was the most significant change. The pushed plug strategy was perceived as a "pushing - move" principle; on the other hand, in this new implementation is more significant "pull - move". In the pushed strategy, "hot" plug entered the feed pipe. The plugs gradually passed through the consumers and ended up as extruded "cooled" plug at the end of the return pipe - back in the producer. The plug quantity is decided by the producer.

On the other hand, in the implemented version of the pull strategy (as mentioned earlier, does not distinguish who is a producer and who the consumer) plugs goes through individual prosumers and they only supply or remove heat. „Pull“ principle because the simulation step begins at the input of the prosumer, usually those who are consuming at the moment. Thus, at the beginning of the simulation step, the plugs move outwardly from the prosumer. This plug is created by pulling the required amount of the waiting plugs at the input of the prosumer into it. These suck plugs are subtracted / supplemented of heat as required in the simulation step. The created plug according to the requirement to maintain the continuity equation pushes plugs that were inserted into the system in the previous steps – they are pushed in front of it. Likewise, suck plug pulls the other, plugs waiting behind it. Under the law of conservation of mass implies that the suck amounts must conform to an extruded. These are analogous behaviour to the real district heating systems, in which the quantity is commonly controlled on the basis of differential pressure. The producer does not dictate how much heating media is entering the system at any given time, but it is given by the demand for individual consumers (pressure drop - flow increase and vice versa)

#### 4. APPLICATION FOR REAL SYSTEM

The implemented pulled plug model was verified on the real operational data of the local district heating operator. The operator has not yet built a 4th generation network, but it was possible to select part of its network with sufficient measuring points. The selected location could be logically separated and explored in offline mode as an island system.



Fig. 2. An aerial view of the selected location

Chosen location, including the deployment of objects, is captured in figure 2. – schematically on figure 3.

The location network topology is represented in the model by the following number element:

- 10 prosumers (9 apartment buildings and 1 heat exchanger station, considered for the experiment as a producer)
- 16 netnodes
- 34 pipesection
- 34 pipelines (for simplicity, each pipesection was defined by only one pipeline)

For a given location is considered the identical structure of the supply and return pipes (16 netnodes composed of 8 nodes on the supply line and 8 on the return. The same applies to pipesections)

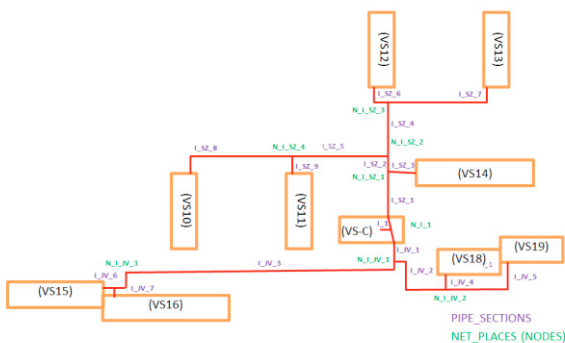

Fig. 3. Schematic representation of a selected location

Verification of the model was carried out on historical data from the operator measurements, which were compared with the course obtained from the model.

##### 4.1 Simulation based on measured data

For the experiments discussed below were used only measured data - the heat or external temperature prediction was not used. The roles of all prosumers were also uniquely defined - all 9 buildings all the time behaved as a consumer and the exchange station as a producer. For each simulation step, each prosumer - consumer was able to uniquely determine its demand for the amount of heat and the outlet water temperature. The prosumer - producer, uses historical data only to set outlet water temperature.

From the above, it can be inferred that the accuracy of the proposed model (for the experiment) can be judged based on the following parameters and characteristics:

1. Producer - Inlet water temperature (return from the distribution network). The model takes care of moving the plugs from the consumer to the producer. Plugs are mixed together and a little cooled - losses in the pipeline.
2. Producer – Mass flow. With regard to the law of conservation, the mass flow in the producer is the sum of the mass flow in individual consumers. The consumers use the measured value of consumed heat and return water temperature. Therefore the flow is affected only at the temperature of the input. Only this value is influenced by the accuracy of the model. The temperature at the moment of the output from the producer corresponds to the measured value, but the inaccuracy of the cooling depends on the quality of the model.
3. Producer - Heat. The heat as a calculated value is determined by the input and output temperature and the flow. As mentioned above, the return water temperature values reflect the inaccuracy of the resulting flow. Of course, these errors are also reflected in the obtained heat.
4. Consumer - Inlet water temperature. As mentioned in point 2 above, the quality of the model can also be judged based on the temperature of the water entering the consumer because its value affects the accuracy of the model (its part between the producer and the given consumer).
5. Consumer – Mass flow. The value of the flow through the consumer depends on the inlet temperature, see point 2. Therefore, from its match with measurement, the model quality can also be assessed.
6. Consumer – Heat. The amount of heat consumed was based on the measured values (this variable was not calculated / predicted for the presented experiment).

#### 4.2 Result for producer

For all charts presented below, the red color shows the measured values, and the blue values obtained (calculated) by the model.

The output water temperature is shown in figure 4. Here is only one curve, as this is not a computed value but set by the operator or controller. The course of these values can be considered as input data for the simulation model of the producer, and as such, these are the same values as in real operation.

Figure 5 shows the comparison of the heat that the producer delivered (measured data) in the reference period with the heat that was calculated for the given prosumer (producer) by the model. Figure 6 compares mass flow and figure 7 the return water temperature.

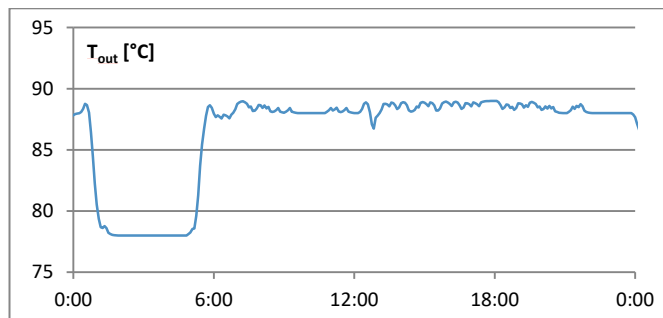

Fig. 4. Producer outlet temperature – heating water

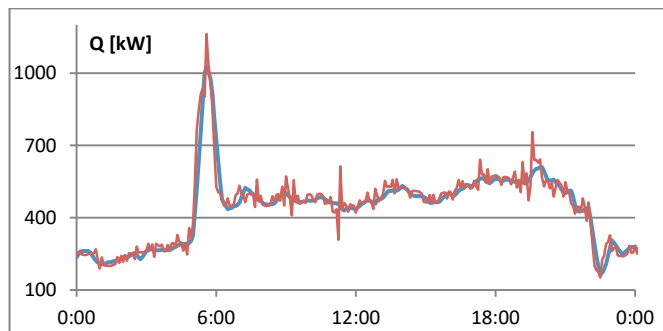

Fig. 5. Heat supplied by the producer (heat exchanger)

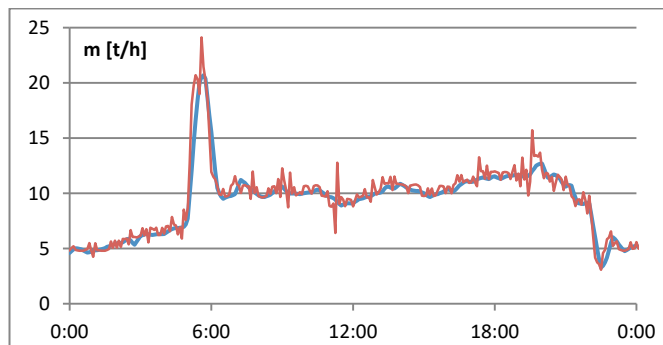

Fig. 6. Producer mass flow

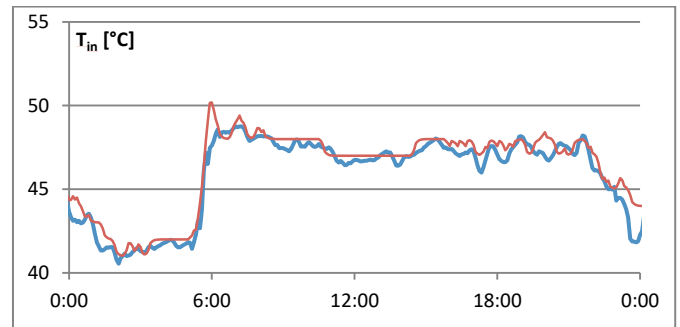

Fig. 7. Producer inlet temperature – returning water

The average deviation of the power (heat) is 28kW, which is about 6% with respect to the average performance in the whole day (440 kW). The average deviation of the return water temperature is 0.5 °C.

#### 4.3 Results for the consumers

The behaviour of the consumers is presented on one selected - object VS10. It is a 9 storey apartment house. For other analysed consumers the results are similar. The VS10 is also suitable for presenting the results of the distribution model, because it is sufficiently distant from the producer, and there are also a number of other objects on its supply pipes.

Figure 8 shows the temperature of the inlet water. Make a comparison with figure 4, which shows the outlet temperature at the producer. Thus, one is of the same variable, only affected by traffic delay and loss of heat (cooling) in the inlet pipe. Figure 9 shows the mass flow. The heat consumed by the object and the outlet water temperature is in figures 10 and 11 (the values from the model are the same as the measurement).

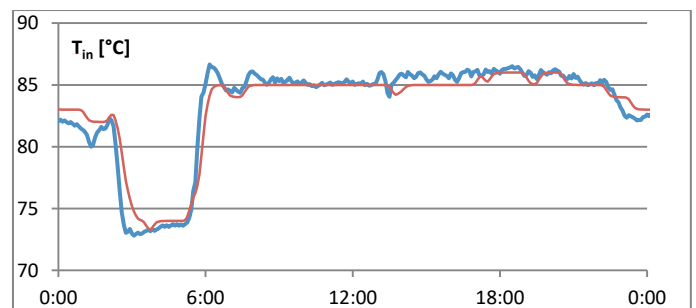

Fig. 8. Consumer inlet temperature – heating water

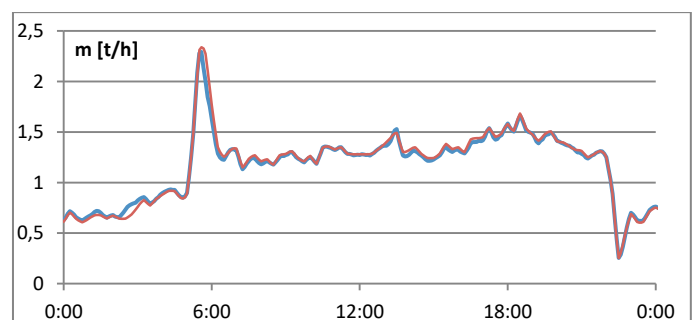

Fig. 9. Consumer mass flow

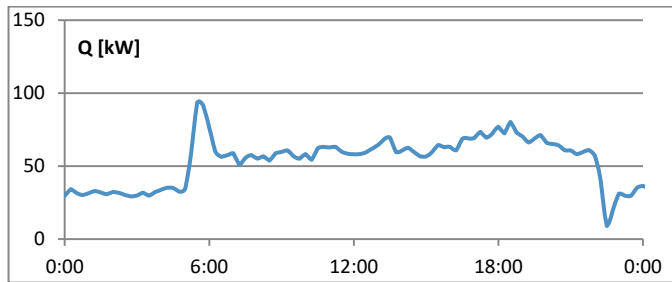

Fig. 10. Heat consumed by the consumer

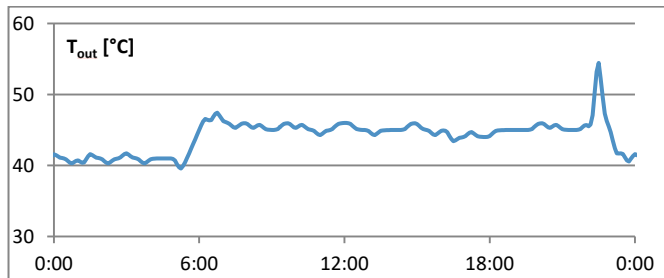

Fig. 11. Consumer outlet temperature – returning water

The average deviation of the heating water temperature is 0.7 °C. The flow deviation is 0.02 t/h - with respect to the average flow during the whole day at about 1.17 t/h it is about 2%. The heat and the return water temperature were applied from the real measurement – so, it makes no sense to compare the output of the model with reality. However, these data are related to the return water – input to the producer and on the course of the mass flow and supplied heat. These data are calculated for the producer by the model („balance of outputs of individual consumers“)

#### 4.4 Discussion of the results

As has been shown in the above presented experiment, the Pulled Plug-flow strategy achieves a good match with the real system. The errors are in the order of percentages, which is an excellent result for the heating area. However, the presented experiment shows only the theoretical case when the consumed heat and output temperature was exactly known (from the historical operational data) - its aim was to verify only the transport parts of developed model for DH. In a realistic deployment with regard to the need to predict at least the heat and the outdoor temperature, it is assumed that there will be an increase in inaccuracy but now achieved results give at least a good starting position hope for a reasonably good result.

### 5. VISION FOR FURTHER DEVELOPMENT AND UTILIZATION

The described model of heat distribution is a part of the research project focusing on modelling, simulation, and control of the whole DH system solved at Tomas Bata University in Zlin, Czech Republic (author's workplace).

As (Lund et al, 2014) pointed, the 4th DH generation is designed to integrate high shares of variable renewable

energy into the district heating by providing high flexibility to the electricity system. And on this idea also focuses proposed solution. The purpose is to provide a support tool that will help to create more efficient energy management. At first glance, it seems to focus on thermal energy, but considering the cogeneration source, the link to flexibility in electricity generation is obvious. An important feature of the proposed tool will be the ability to control the DH system using the values of its characteristics and requirements from its significant surroundings, predicted with the appropriate time in advance. Therefore, the further development of the presented distribution model will focus on such adjustments that will allow the use of prediction data - in particular, the prediction of heat consumption by individual consumers. Further work will focus on integrating the distribution model into the DH model, which will be used for the purpose stated above.

#### ACKNOWLEDGMENT

This work was supported by the Technology Agency of the Czech Republic within the project No. TH02020979 (Distributed control system for regional heat and cooling supply conceived as Smart Energy Grid)

#### REFERENCES

- Bulut M. B., Odlare M., Stigson P., Wallin F., Vasilleva I. (2016). Active buildings in smart grids—Exploring the views of the Swedish energy and buildings sectors, *Energy and Buildings*, Volume 117, p. 185-198.
- Kral E., Vasek L., Dolinay V., Capek P. (2011). The Use of Peak Functions in Heat Load Modeling of District Heating System, *International journal of mathematical models and methods in applied sciences*, Volume 5, Issue 7.
- Lund, H., Werner, S., Wiltshire, R., Svendsen, S., Thorsen, J. E., Hvelplund, F., Mathiesen, B. V. (2014), 4th Generation District Heating (4GDH): Integrating smart thermal grids into future sustainable energy systems, *Energy*, Volume 68, p. 1-11.
- Starkloff R., Alobaid F., Karner K., Epple B., Schmitz M. Boehm F. (2015), Development and validation of a dynamic simulation model for a large coal-fired power plant, *Applied Thermal Engineering*, Volume 91, p. 496-506.
- Tilia GmbH (2016). *Efficient district heating and cooling systems in the EU*, p. 9.
- Vasek L., Dolinay V., Vasek V. (2014). Simulation Model of a Smart Grid with an Integrated Large Heat Source, *IFAC Proceedings Volumes (IFAC-PapersOnline)*, Volume 1947, Issue 3, p. 4565-4570.
- Vasek, L., Dolinay, V. (2017). Steps towards modern trends in district heating, *MATEC Web of Conferences*, Volume 125.
- Vasek, L., Dolinay, V. (2015). The proposal of the holonic control for the district heating systems. *Recent Advances in Systems*, p. 559-563.
- Werner S. (2017). International review of district heating and cooling, *Energy*, Volume 137, p. 617-631.