

# Unstable Systems - Tracking and Disturbance Attenuation

ROMAN PROKOP, NATALIA VOLKOVA, ZDENKA PROKOPOVÁ

Tomas Bata University in Zlin

nám. TGM 5555, 760 01 Zlin, Czech Republic

*e-mail:* prokop@fai.utb.cz

*Abstract:* The paper is aimed to the design of linear continuous controllers for unstable single input – output systems. The controller design is studied in the ring of (Hurwitz) stable and proper rational functions  $R_{PS}$ . All stabilizing feedback controllers are given by a general solution of a Diophantine equation in  $R_{PS}$ . Then asymptotic tracking and disturbance attenuation is obtained through the divisibility conditions in this ring. The attention of the paper is focused on a class of unstable systems. Both, one and two degree of freedom (1DOF, 2DOF) control structures are considered. Control loops with a feedforward part significantly reduce overshoots in control responses. The methodology brings a scalar parameter for tuning and influencing of controller parameters. As a result, a class of PI, PID controllers are developed but the approach generates also complex controllers. Simulations and verification are performed in the Matlab+Simulink environment.

*Keywords:* Unstable systems, Diophantine equation, asymptotic tracking, Disturbance attenuation.

## 1 Introduction

The dynamics of many technological plants exhibit unstable behavior. Probably, the reason can be seen in nonlinearity of many industrial processes and plants. Such nonlinear systems exhibit multiple steady states and some of them may be unstable. The situation where linear systems have unstable poles may occur e.g. in a continuous-time stirred exothermic tank reactor, in distillation columns, in polymerization processes or in a class of biochemical processes where the processes must operate at an unstable steady state. Moreover, a time delay can be also an inherent part of many technological plants.

The most frequent tool for feedback industrial control has been still PID controller. It is believed that more than 90 % feedback loops are equipped with this controller. Also, a great amount for PID assessing and tuning rules has been developed. The traditional engineering design approach of PID like controllers was performed either in the frequency domain or in polynomial representation (see e.g. [1], [2], [3]). Most of them are scheduled for stable systems without or with time delay, see e.g. [1], [2]. The unstable cases are studied e.g. in [4], [5].

In this contribution, a general technique for a class of unstable systems is proposed. The control design is performed in the ring of proper and Hurwitz stable rational functions  $R_{PS}$ . All stabilizing controllers are given by all solutions of Diophantine equation in this ring and asymptotic tracking and disturbance attenuation is then formulated by additional conditions of divisibility. This fractional approach proposed in [6], [10], [17] enables a deeper insight into control tuning and a more elegant

derivation of all suitable controllers. The situation and details for stable and time-delay free systems can be found in [12] - [16] for various control problems. This technique introduces a scalar parameter  $m > 0$  which influences a control responses and also robust behaviour. The  $R_{PS}$  ring also enables to utilize the  $H_\infty$  norm as a tool for perturbation evaluation.

## 2 Descriptions over Rings

Linear continuous-time dynamic systems have been traditionally described by the Laplace transform. So polynomials became a basic tool for the stability analysis and controller design. Since the characteristic feedback polynomial has two known (plant) and two unknown (controller) polynomials, the Diophantine equations began to penetrate into synthesis method, see e.g. [10]. However, the ring of polynomials induces some drawbacks with solutions of Diophantine equations. Almost all from the infinite number of solutions cannot be used for controller transfer functions because they are not proper, see e.g. [11], [15]. These problems were overcome by introducing of the different ring of proper and stable rational functions. The pioneering work in the so called fractional approach is the work [18], further extension can be found in [11], [15]. Simply speaking, a ratio of polynomials is replaced by a ratio of two Hurwitz stable and proper rational functions. In this paper, the following ring  $R_{PS}(m)$  is utilized.

Transfer functions of linear single input – single output dynamic systems have been traditionally expressed as a ratio of two polynomials. The set of polynomials (for continuous-time systems in the

Laplace transform with the indeterminate  $s$ ) is a ring [11], [15], [18]. However, there are various rings for studying specific features [11], [18]. The ring  $R_{PS}(m)$  denotes the set of rational functions having no poles in the plane  $Re(s) \geq m$ . It means that this set includes all Hurwitz stable and proper rational functions in this region. The transcription of a transfer function is very simple, numerator and denominator is divided by the same stable polynomial of the appropriate degree. Generally, polynomial transfer functions in the ring  $R_{PS}(m)$  take the form:

$$G(s) = \frac{b(s)}{a(s)} = \frac{(s+m)^n}{a(s)}; \quad (1)$$

$$n = \max(\deg a, \deg b)$$

where  $m > 0$ . Also, signals in control systems can be expressed similarly. The stepwise reference signal  $w$  and harmonic disturbance  $v$  are in the rational description given by ratios:

$$w = \frac{1}{s} = \frac{G_w}{F_w} = \frac{1}{s} \quad (2)$$

$$v = \frac{G_v}{F_v} = \frac{1}{\frac{s+\omega^2}{(s+m)^2}} \quad (3)$$

The load disturbance  $n$  is supposed also in the form of (2), (3). The divisibility of elements in  $R_{ps}$  is defined through the all unstable zeros (including infinity) of the rational functions, see [18] for details.

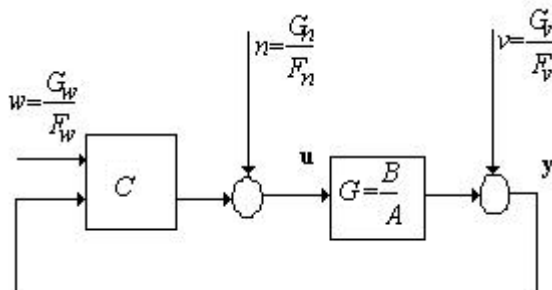

Fig.1. General closed loop system

The basic control problem is then formulated as follows within the context of Fig.1: Consider the known transfer function (1), the reference and disturbance (2), (3). The task is to design a proper transfer function  $C(s)$  so that the closed loop system

is asymptotic stable and the tracking error  $e(t) = w(t) - y(t)$  tends to zero. Moreover, a stepwise disturbance  $n(t)$  has to be eliminated without a non-zero steady-state error (disturbance attenuation). Naturally, many other syntheses can be found in literature. A handbook for general utilization of PI, PID controllers is [22]. Integrating time delay systems are studied in [19], [21], [23]. Robust control is referred in [20] while general stabilization is analyzed in [24]. Experimental verification of PI/PID controllers is analyzed in [25] and control with time-varying delay is studied in [27].

### 3 Control and Disturbance Rejection Design in $R_{PS}$

Suppose a general closed loop control system depicted in Fig.1. The controller  $C(s)$  generates the control variable  $u$  according the equation:

$$Pu = R w - Q y + n \quad (4)$$

where  $n$  is a load disturbance. Note that a traditional one degree-of-freedom (1DOF) feedback controller operating on the tracking error is obtained for  $Q = R$ . This structure is shown in Fig. 2 while the 2DOF structure (without load disturbance) is depicted in Fig.3.

Basic relations following from the 2DOF configuration are

$$y = \frac{B}{A} u + v \quad u = \frac{R}{P} w - \frac{Q}{P} y + n \quad (5)$$

and  $w, v, n$  are independent external inputs into the closed loop system.

Further, the following equations hold:

$$y = \frac{BR}{AP+BQ} \frac{G_w}{F_w} + \frac{AP}{AP+BQ} \frac{G_v}{F_v} + \frac{BP}{AP+BQ} \frac{G_n}{F_n} \quad (6)$$

The 1DOF (FB) structure is obtained for  $R=Q$  (depicted in Fig.2) and the last relation gives the controlled error  $e = w - y$ :

$$e = \frac{AP}{AP+BQ} \frac{G_w}{F_w} + \frac{AP}{AP+BQ} \frac{G_v}{F_v} + \frac{BP}{AP+BQ} \frac{G_n}{F_n} \quad (7)$$

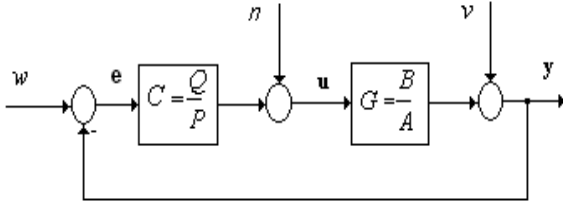

Fig.2. Structure 1DOF (FB) of the close loop system

The first step of the control design is to stabilize the system by a proper feedback loop. It can be formulated in an elegant way in  $R_{PS}$  by the Diophantine equation:

$$AP + BQ = 1 \tag{8}$$

with a general solution for SISO systems  $P = P_0 + BT$ ,  $Q = Q_0 - AT$ ; where  $T$  is free in  $R_{PS}$  and  $P_0, Q_0$  is a pair of particular solutions (Youla – Kučera parameterization of all stabilizing controllers). Details and proofs can be found e.g.[10], [15], [16], [18]. Then control error for the 2DOF structure:

$$e = (1 - BR) \frac{G_w}{F_w} + AP \frac{G_v}{F_v} + BP \frac{G_n}{F_n} \tag{9}$$

Now, it is necessary to solve both structures 1DOF and 2DOF separately. For asymptotic tracking and the 2DOF (FBFW) structure, the second Diophantine equation gets the form:

$$F_w Z + BR = 1 \tag{10}$$

where  $Z \in R_{PS}$  is not used in the control law.

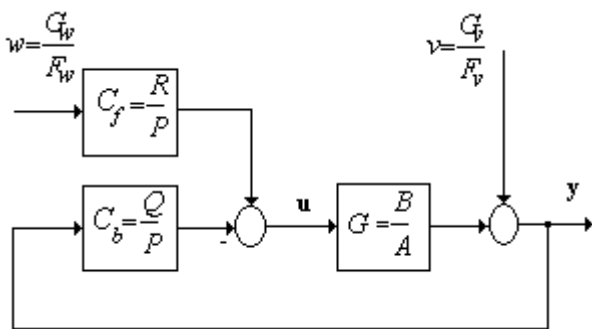

Fig.3. Structure 2DOF (FBFW) of the close loop system

The tracking error  $e$  tends to zero if

a)  $F_w$  divides  $AP$  for 1DOF (11)

b)  $F_w$  divides  $1 - BR$  for 2DOF (12)

Another control problem of practical importance is disturbance rejection and disturbance attenuation. In both cases, the effect of disturbances  $v$  and  $n$  should be asymptotically eliminated from the plant output. Since the both disturbances are external inputs into the feedback part of the system, the effect must be processed by a feedback controller. It means that the second and third parts in (11) and (12) are

$$\frac{AP}{AP + BQ} \frac{G_v}{F_v} \tag{13}$$

$$\frac{BP}{AP + BQ} \frac{G_n}{F_n} \tag{14}$$

They must belong to  $R_{PS}(s)$ , i.e. all  $AP + BQ, F_v, F_n$  should cancel. In other words, a multiple  $F_v, F_n$  must divide  $P$ . More precisely  $F_v$  must divide the multiple  $AP$  and  $F_n$  the multiple  $BP$ . When define relatively prime elements  $A_0, F_{v0}$  and  $B_0, F_{n0}$  in  $R_{PS}(s)$

$$\frac{A}{F_v} = \frac{A_0}{F_{v0}}, \quad \frac{B}{F_n} = \frac{B_0}{F_{n0}} \tag{15}$$

Then the problem of disturbance rejection and attenuation is solvable if and only if the pairs  $F_v, B$  and  $F_n, B$  are relatively prime and the feedback controller is given by

$$C_b = \frac{Q}{P} = \frac{Q}{P_1 F_{v0} F_{n0}} \tag{16}$$

where  $P_1, Q$  is any solution of the equation

$$AF_{v0} F_{n0} P_1 + BQ = 1 \tag{17}$$

### 4 Simple controllers for unstable systems

The fractional approach performed in the ring  $R_{PS}$  enables a control design in a very elegant way. Probably, the simplest unstable system is an integrator with the transfer function:

$$G(s) = \frac{b_0}{s} \tag{18}$$

The basic stabilizing equation (8) takes the form

$$\frac{s}{s + m} p_0 + \frac{b_0}{s + m} q_0 = 1 \tag{19}$$

and all solutions can be expressed by

$$P = 1 + \frac{b_0}{s + m} T; \quad Q = \frac{m}{b_0} - \frac{s}{s + m} T \tag{20}$$

with  $T$  free in  $R_{ps}$ . For the integrator, the condition of divisibility between stepwise  $F_w$  and  $A$  is generically fulfilled because they are the same rational function (as well as polynomial) in the form (2). Then the simplest 1DOF controller is proportional with the gain  $m/b_0$ . The influence of tuning parameter  $m$  is shown in Fig.4 where responses for three various parameters are depicted ( $b_0=1$ ). Naturally, this controller is not able to compensate any load disturbance. The simulation in Fig.4 represents the reference (stepwise) change in time  $t=15$  and the load disturbance (also stepwise) is injected in  $t=20$ . In this case, the 2DOF structure does not bring any improvement. The steady-state error is inversely proportional to the gain of the controller, so the tuning parameter  $m>0$ . The steady-state error decreases with increasing parameter  $m>0$ .

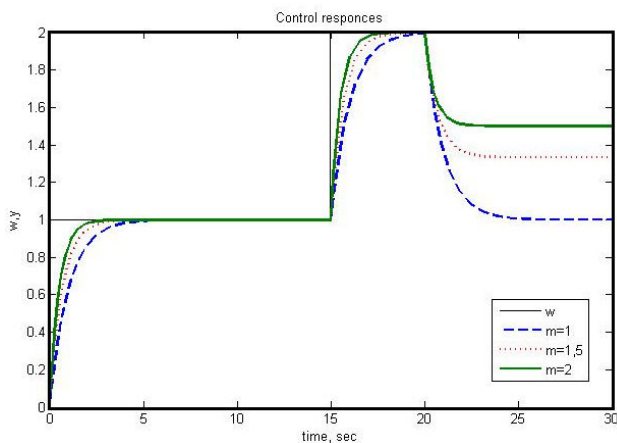

Fig.4. Simple integrator with P controller with 1DOF control structure

Now, it is necessary to find such a free parameter  $T$  in (20) so that controller  $C_b = \frac{Q}{P}$  ensures asymptotic tracking for a stepwise load disturbance (2). So, the condition (11) is achieved for  $t_0 = -\frac{m}{b_0}$  and the 1DOF controller takes the form of PI one:

$$\frac{Q}{P} = \frac{\frac{2m}{b_0}s + \frac{m^2}{b_0}}{s} \quad (21)$$

It is clear that tuning parameter  $m$  is incorporated into controller parameters in a nonlinear way. The influence for control behaviour is then demonstrated in Fig. 5 (also for  $b_0=1$ ). Typical PI (1DOF) response exhibit a small overshoots.

The feedforward part of the 2DOF structure for integrator (18) is given by (10) with the general solution for  $R$ :

$$R = \frac{m}{b_0} + \frac{s}{s+m}T \quad (22)$$

which for  $t_0 = -\frac{m}{b_0}$  gives  $R(s) = \frac{m^2}{b_0(s+m)}$ . The final control law (4) for 2DOF structure takes the relation

$$u(t) = \frac{m^2}{b_0} \int_0^t (w - y(\tau))d\tau + \frac{2m}{b_0} y(t) \quad (23)$$

The control law (23) is a generalized PI controller propose by Aström in [1], [3] as a tool against overshooting. Fig. 6 shows the control responses for the same values of  $m>0$ . Vanishing of overshoots confirm this fact.

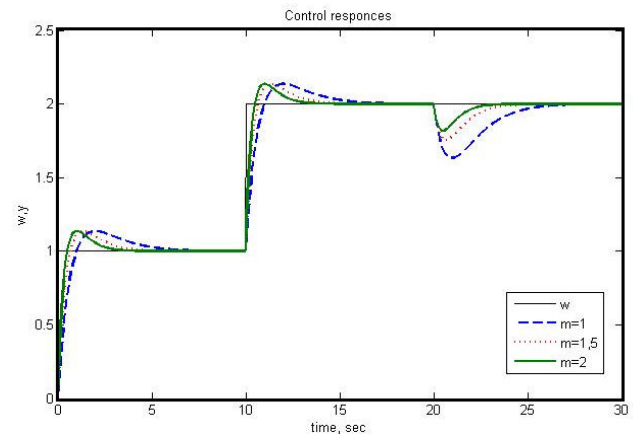

Fig.5. Simple integrator with PI controller (1DOF structure)

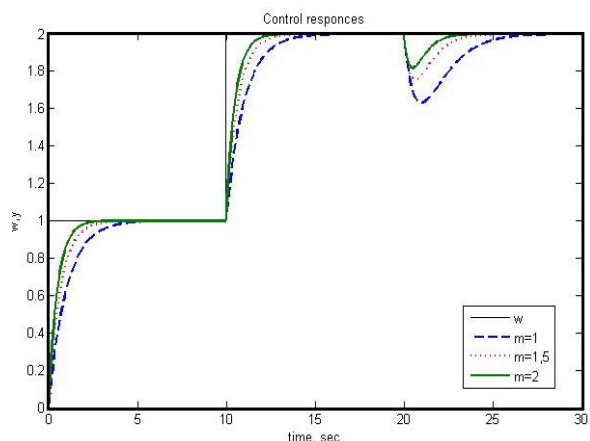

Fig.6. Simple Integrator with PI controller (2DOF control structure)

A bit more complex situation occurs for disturbance rejection with harmonic signal (3). Then the parameterization (20) leads to the expression:

$$P = 1 + \frac{b_0}{s+m} \frac{t_1 s + t_0}{s+m} \approx \frac{s^2 + \omega^2}{(s+m)^2} \quad (24)$$

It is necessary to find parameters  $t_0, t_1$  satisfying the identity in (22). Equating of coefficients in (22), the following linear equations for  $t_0, t_1$  are:

$$\begin{aligned} 2m + b_0 t_1 &= 0 \\ m^2 + t_0 &= \omega^2 \end{aligned} \quad (25)$$

with the solution  $t_1 = -\frac{2m}{b_0}$ ;  $t_0 = \omega^2 - m^2$ .

The resulting feedback controller  $C(s) = \frac{Q}{P}$  has no more of the PI or PID structure but it takes the form:

$$\frac{Q}{P} = \frac{q_2 s^2 + q_1 s + q_0}{s^2 + \omega^2} \quad (26)$$

where

$$q_2 = \frac{m}{b_0} - t_1; \quad q_1 = \frac{2m^2}{b_0} - t_0; \quad q_0 = \frac{m^3}{b_0} \quad (27)$$

The control responses for three different values of  $m > 0$  are depicted in Fig.7.

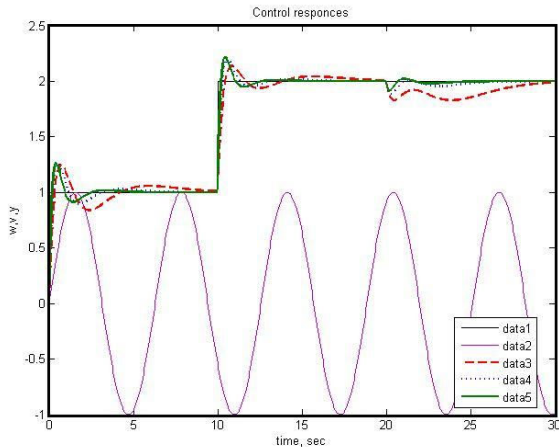

Fig.7. Simple integrator with harmonic disturbance compensation with 1DOF control structure

The feedforward part of the 2DOF control law is derived in similar way like in (22). The second Diophantine equation has the form

$$\frac{s}{s+m} Z + \frac{b_0}{s+m} R = 1 \quad (28)$$

with the same solution (22). The resulting feedforward transfer function has the form

$$\frac{R}{P} = \frac{r_0 (s+m)^2}{s^2 + \omega^2}, \quad (29)$$

where  $r_0 = \frac{m}{b_0}$ .

The control responses are shown in Fig.8. Here (also in Fig.7), the depicted harmonic signal represents an injected disturbance  $v$  in the sense of Fig. 1, Fig. 2. The influence of the feedforward part is similar as in PI reference tracking. The feedforward part reduces overshoots while parameter  $m > 0$  influences the dynamics (speed) of control responses.

Two remarkable facts can be seen in Fig.5 - Fig.8. The first one is that increasing value of the tuning parameter  $m$  lessens overshoot of the control response. The second one is that the divisibility condition enables to compensate the stepwise load disturbance which is injected in the time  $t=20$ .

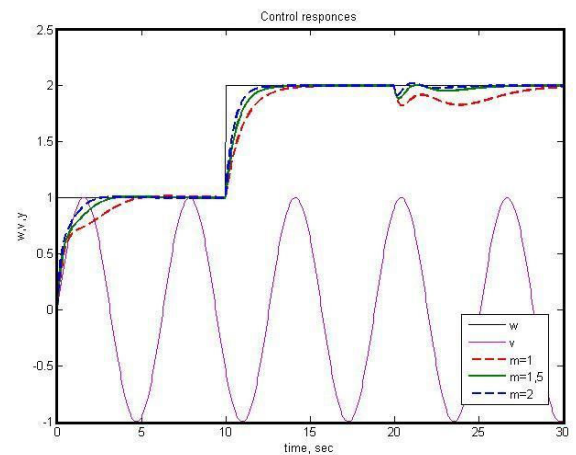

Fig.8. Integrator with harmonic disturbance compensation with 2DOF control structure

A second set of controllers for unstable systems can be derived for system governed by the transfer function:

$$G(s) = \frac{b_0}{s - a_0} \quad (30)$$

with  $a_0 > 0$ . The stabilization feedback equation (8) takes the form

$$\frac{s - a_0}{s + m} p_0 + \frac{b_0}{s + m} q_0 = 1 \quad (31)$$

with all parameterization solutions

$$P = 1 + \frac{b_0}{s+m} T; \quad Q = \frac{m + a_0}{b_0} - \frac{s - a_0}{s+m} T \quad (32)$$

In this case (for the stepwise reference) the divisibility condition  $F_w | AP$  is not generically fulfilled and it is achieved for  $T = t_0 = -\frac{p_0 m}{b_0}$ . The final feedback part is again in the form of PI controllers:

$$\frac{Q}{P} = \frac{q_1 s + q_0}{s} \quad (33)$$

where

$$q_1 = \frac{2m + a_0}{b_0}; \quad q_0 = \frac{m^2}{b_0} \quad (34)$$

Simulations for three values  $m$  (0.6, 1.0, 2.5) for the particular case  $b_0=2, a_0=0.5$  are shown in Fig.9.

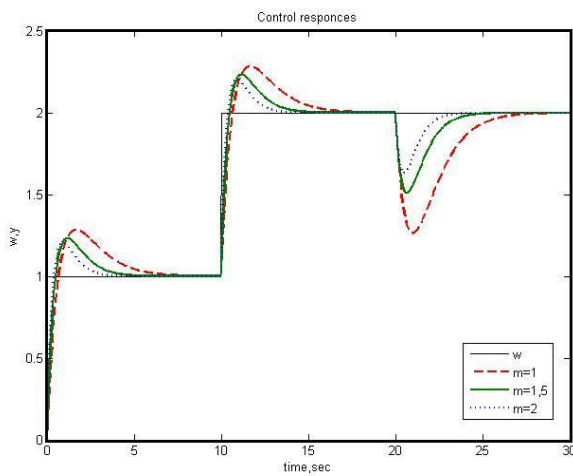

Fig.9. Unstable system (30) with 1DOF control structure

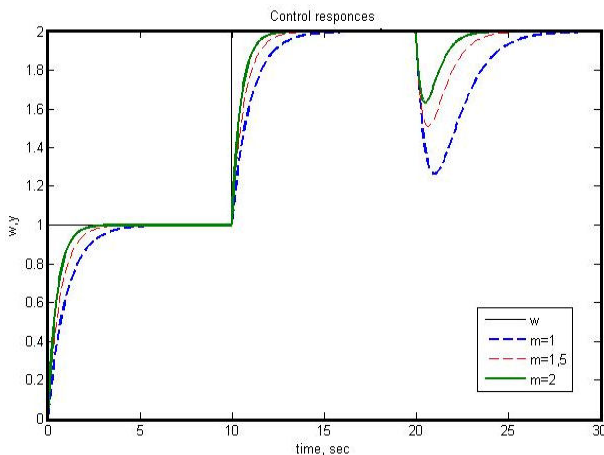

Fig.10. Unstable system (30) with 2DOF control structure

Another question is a total rejection of overshoot. It can be achieved by utilizing of control structure 2DOF and equation (10) which has the same form and general solution (22). The final control law has also the form of a generalized PI controller. In

contrast to (23) plant parameter  $a_0$  is immersed into control law:

$$u(t) = \frac{m^2}{b_0} \int_0^t (w - y(\tau)) d\tau + \frac{2m + a_0}{b_0} y(t) \quad (35)$$

The control responses for three value of  $m$  (1.0, 1.5, 2.0) are depicted in Fig.10. Generally, the 2DOF structure always reduces overshoots after step changes of input signals (reference, load disturbance).

Also the harmonic disturbance attenuation can be overcome similarly as in the case of a simple integrator. In the general solution of stabilizing controller in (32) the following divisibility condition has to be fulfilled:

$$P = 1 + \frac{b_0}{s + m} T \text{ is divisible by } \frac{s(s^2 + \omega^2)}{(s + m)^3} \quad (36)$$

Condition (36) can be achieved by the choice

$$T = \frac{t_2 s^2 + t_1 s + t_0}{(s + m)^2} \quad (37)$$

After some algebraic manipulations a bit more complex than in (25) – (27) the final feedback transfer function is in the form

$$\frac{Q}{P} = \frac{q_3 s^3 + q_2 s^2 + q_1 s + q_0}{s(s^2 + \omega^2)} \quad (38)$$

The explicit expressions for controller parameters are quite complex, see [16] for details.

The control responses for the 1DOF structure are shown in Fig. 11. The feedforward part of the 2DOF structure follows from the second Diophantine equation (10) which has the identical general solution (22). The final

$$\frac{R}{P} = \frac{r_0 (s + m)^3}{s(s^2 + \omega^2)}, \quad (39)$$

where  $r_0 = \frac{m}{b_0}$ . The control responses for the same

values and conditions are shown in Fig. 12. The last two figures again confirm the fact that the 2DOF structure reduces overshoots also in the presence of harmonic disturbances. The load disturbance attenuation and disturbance can be achieved simultaneously as it is shown in Fig. 15 – Fig. 20 for the next second order system.

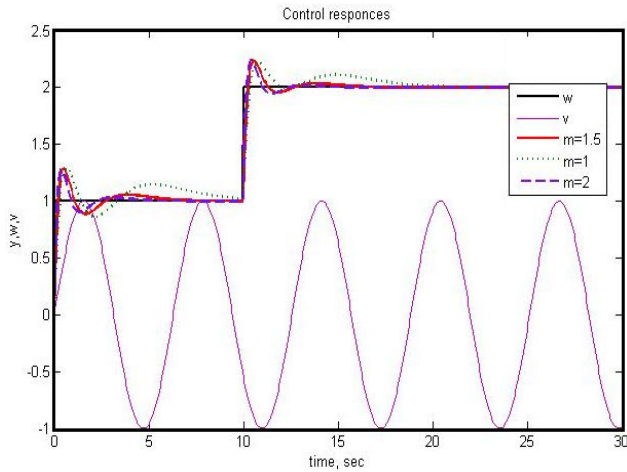

Fig. 11. Unstable system (30) with harmonic disturbance compensation with 1DOF control structure

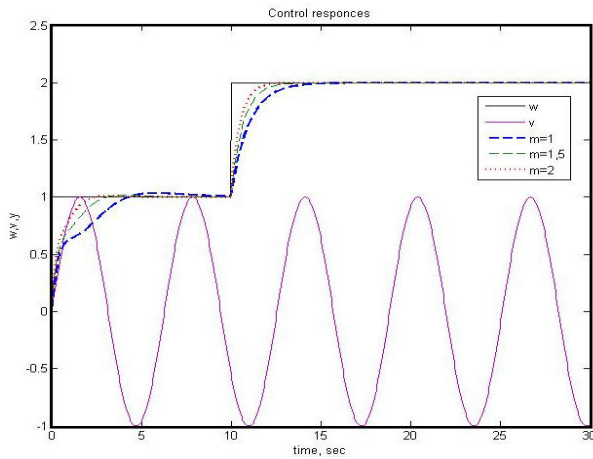

Fig. 12. Unstable system (30) with harmonic disturbance compensation with 2DOF control structure

The third class of controllers is derived for a frequent case of unstable systems with the integrator in the form

$$G(s) = \frac{b_0}{s(s - a_0)} \quad (40)$$

The divisibility condition for a step-wise reference with  $F_w = \frac{s}{s+m}$  is fulfilled, so the stabilizing equation (8) also ensures asymptotic tracking. This equation in this case takes the form

$$\frac{s(s - a_0)}{(s+m)^2} \frac{p_1s + p_0}{(s+m)} + \frac{b_0}{(s+m)^2} \frac{q_1s + q_0}{(s+m)} = 1 \quad (41)$$

It is easy to express parameters  $p_i$ ,  $q_i$  and the particular controller has the transfer function

$$\frac{Q}{P} = \frac{q_1s + q_0}{p_1s + p_0} \quad (42)$$

where

$$p_1 = 1; \quad p_0 = 3m + a_0; \quad q_1 = \frac{3m^2}{b_0} + a_0(3m + a_0); \quad q_0 = \frac{m^3}{b_0} \quad (43)$$

Simulations for the case  $b_0=1$  and  $a_0=0.5$  and three parameters are shown in Fig.13 with the 1DOF structure.

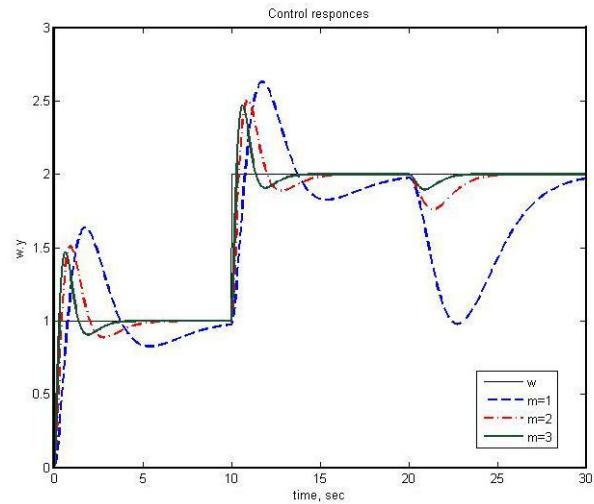

Fig. 13. Unstable system (40) with 1DOF control structure

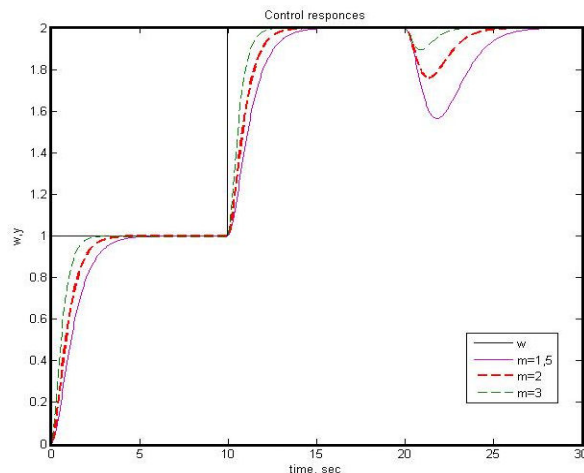

Fig. 14. Unstable system (40) with 2DOF control structure

The 2DOF control synthesis is derived in a very similar way like in (28), (29). The simulation responses for (40) are depicted in Fig. 14. Naturally, it is possible to derive a controller for harmonic disturbance rejection.

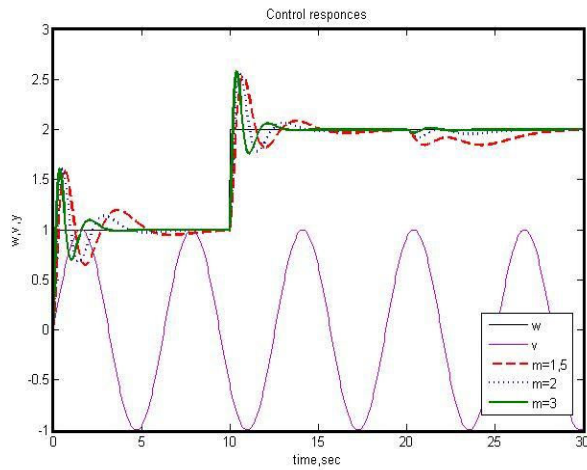

Fig.15. Unstable system (40) with harmonic disturbance compensation (frequency=1, amplitude=1) with 1DOF control structure

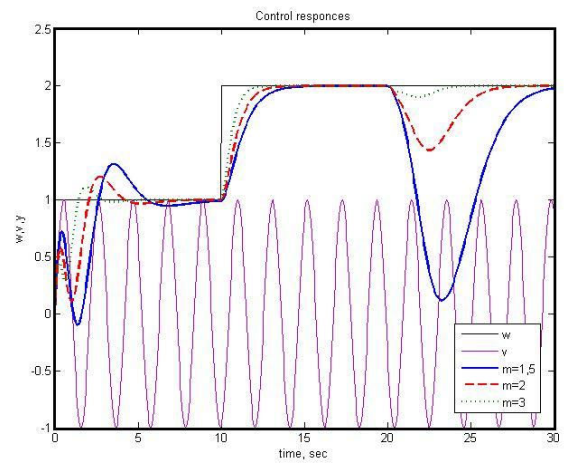

Fig.18. Unstable system (40) with harmonic disturbance compensation (frequency=3, amplitude=1) with 2DOF control structure

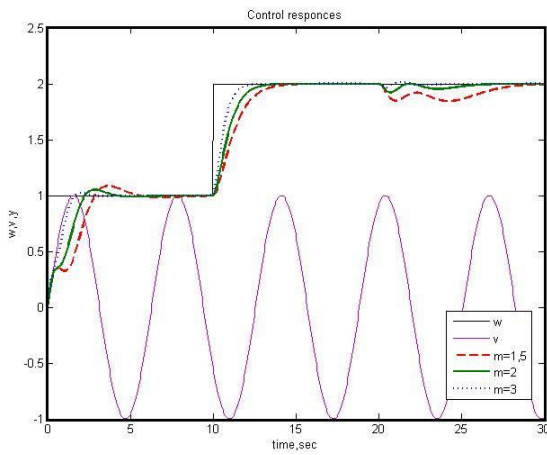

Fig.16. Unstable system (40) with harmonic disturbance compensation (frequency=1, amplitude=1) with 2DOF control structure

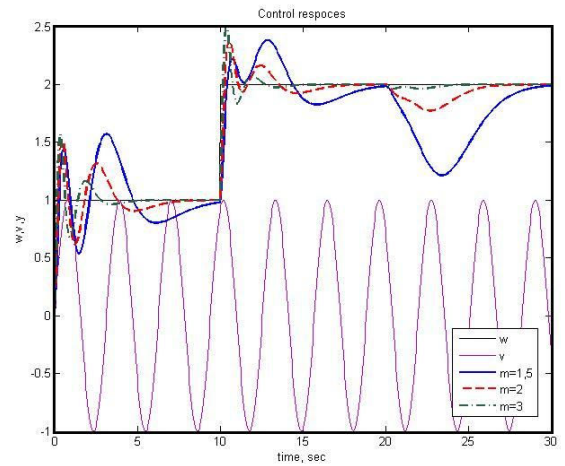

Fig.19. Unstable system (40) with harmonic disturbance compensation (frequency=2, amplitude=1) with 1DOF control structure

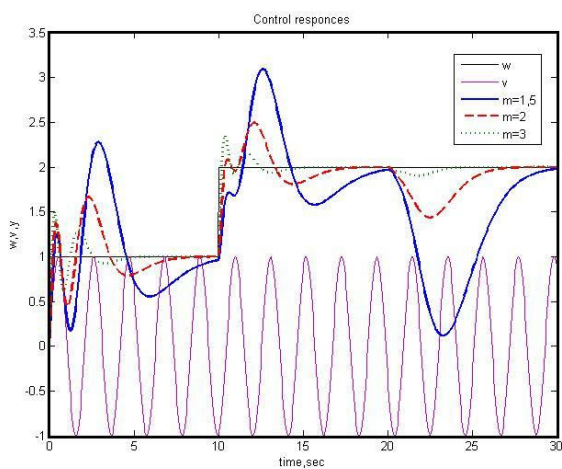

Fig.17. Unstable system (40) with harmonic disturbance compensation (frequency=3, amplitude=1) with 1DOF control structure

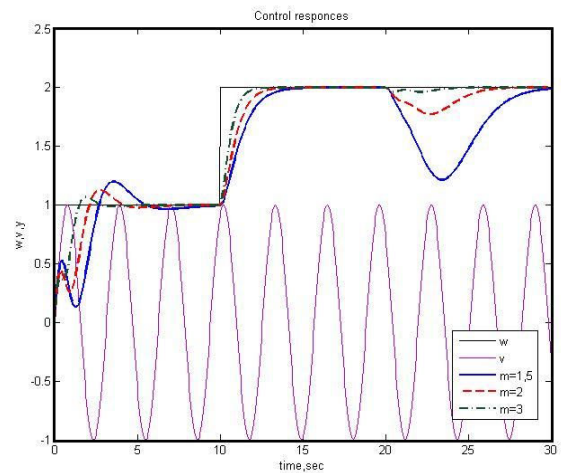

Fig.20. Unstable system (40) with harmonic disturbance compensation (frequency=2, amplitude=1) with 2DOF control structure



The synthesis is based on equation (17) for the 1DOF structure and on equation (10) for the 2DOF structure. The final explicit expressions are not simple and can be found in [16], [19]. The simulation responses are shown in Fig. 15

– Fig. 20. All simulations represent simultaneous disturbance rejection and load disturbance attenuation for various frequency of the harmonic disturbance. Simulations confirm the fact that the 2DOF structure lessens the overshoots after step changes of the reference. However, the increasing frequency of the harmonic disturbance implicate the increasing overshoots (undershoots) after the load disturbance injection. It is obvious from Fig. 15, 17, 19 for the 1DOF structure as well as Fig. 16, 18, 20 for the 2DOF structure.

## 5 Conclusions

The task of simultaneous regulation and disturbance attenuation for a class of unstable systems is considered. A controller design methodology is based on the fractional representation in the ring of proper and stable rational functions. Resulting control laws in 1 DOF structure give a class of PI or PID controllers. It is important from application point of view. The a bit more complex structure 2 DOF gives more sophisticated controllers which have no more the PID structure but the benefit is in control responses. The proposed methodology brings a scalar parameter  $m > 0$  which enables to tune and influence the robustness and control behaviour. The tuning parameter can be chosen arbitrarily or it can be a result of some optimization or calculation. Also problems of disturbance attenuation are analysed. The methodology is applied for three most frequent cases of unstable systems of the first and second order. All simulations were simulated and verified in the Matlab + Simulink environment.

## Acknowledgments

This work was supported by the Ministry of Education, Youth and Sports of the Czech Republic under the Research Plan No. MSM 7088352102 and by the European Regional Development Fund under the project CEBIA-Tech No. CZ.11.05./2.1.00/ 03 .0089.

## References:

- [1] K.J. Aström, C.C. Hang, P. Persson, and W.K. Ho, Towards intelligent PID control. *Automatica*, Vol. 28, No.1, 1992, pp. 1-9.
- [2] K.J. Aström, C.C. Hang and B.C. Lim, A new Smith predictor for controlling a process with an integrator and long dead-time. *IEEE Trans. on AC*, Vol. 39, No. 2, 1994, pp. 343-345.
- [3] K.J. Aström and T. Häggglund, *PID Controllers: Theory, Design and Tuning*. Instrument Society of America, USA, 1995.
- [4] A.M. De Paor and M.O'Malley, Controllers of Ziegler Nichols type for unstable processes. *Int. J. Control*, Vol. 49, 1989, pp. 1273-84.
- [5] V. Venkatasankar and M. Chidambaram, Design of P and PI controllers for unstable first-order plus time delay systems, *Int. J. Control*, Vol. 60, No. 1, 1994, pp. 137-144.
- [6] C.D. Doyle, B.A. Francis and A.R. Tannenbaum, *Feedback Control Theory*. Macmillan, New York, 1992.
- [7] A. Filasová and D. Krokavec, Decentralized robust control design using LMI. In: *Acta Montanica Slovaca*, Vol.13, No. 1, 2008, pp. 100-104.
- [8] M.J. Grimble and V. Kučera, *Polynomial Methods for Control Systems Design*. Springer, Berlin, 1996.
- [9] S.H. Hwang, S.J. Shiu and M.L. Lin, PID control of unstable systems having time delay. In: *Prepr. IFAC ECC Bruxelles*, No.559, 1997, pp.229-235.
- [10] T. Kailath, *Linear system*, Prentice Hall, Englewood Cliffs, 1980.
- [11] V. Kučera, Diophantine equations in control - A survey, *Automatica*, Vol. 29, No.6, 1993, pp. 1361-75.
- [12] R. Padma Sree and M.Chidambaram, *Control of Unstable Systems*. Alpha Science Int., Oxford, 2006.
- [13] R. Matušů and R. Prokop, Robust Stabilization of Interval Plants using Kronecker Summation Method. In: *Last Trends on Systems, 14th WSEAS International Conference on Systems*, Corfu Island, Greece, 2010, pp. 261-265.
- [14] L. Pekař and R. Prokop, Non-delay depending stability of a time-delay system. In: *Last Trends on Systems, 14th WSEAS International Conference on Systems*, Corfu Island, Greece, 2010, pp. 271-275.
- [15] R. Prokop, L. Pekař and J. Korbel, Autotuning for delay systems using meromorphic functions. In: *Proceedings of the 9th IFAC Workshop on Time Delay Systems*, Prague, Czech Rep., 2010, pp. [CD-ROM].
- [16] R. Prokop and J.P. Corriou Design and analysis of simple robust controllers, *Int. J. Control*, Vol. 66, No. 6, 1997, pp. 905-921.

- [17] R. Matušů, K. Vaneková, R. Prokop and M. Bakošová, Design of Robust PI Controllers and their Application to a Nonlinear Electronic System, , *Journal of Electrical Engineering*, Bratislava, 2010, pp. 44-51.
- [18] M. Vidyasagar, *Control system synthesis: A factorization approach*. MIT Press, Cambridge, M.A., 1985.
- [19] L. Pekař and R. Prokop, Control of Delayed Integrating Processes Using Two Feedback Controllers: RMS Approach, In: *Proceedings of the 7th WSEAS International Conference on System Science and Simulation in Engineering*, Venice, 2008, pp. 35-40.
- [20] D. Krokavec and A. Filasová, Pole assignment in robust state observer design. In: *AT&P Journal* . Vol. 12, č. 2 (2007), s. 75-78.
- [21] T.Vyhlídal, Anisochronic first order model and its application to internal model control, In: *Preprints of ASR '2000 Seminar*. Prague,2000, pp. 21-31.
- [22] O'Dwyer, *Handbook of PI and PID controller tuning rules*. London: Imperial College Press, 2003.
- [23] L. Pekař, & R. Prokop: Algebraic Control of integrating Processes with Dead Time by Two Feedback Controllers in the Ring RMS. *Int. J. of Circuits, Systems and Signal Processing*, Volume 2, Issue 4, 2008, pp. 249-263. ISSN: 1998-4464.
- [24] L. Pekař & R. Prokop. Stabilization of a delayed system by a proportional controller. *International Journal of Mathematical Models and Methods in Applied Sciences*, Volume 4, Issue 4, 2010, pp. 282-290. ISSN: 1998-0140.
- [25] R. Matušů & R. Prokop. Experimental verification of design methods for conventional PI/PID controllers. *WSEAS Trans. on Systems and Control*, Vol. 5, Issue 5, 2010, pp.269-280.
- [26] R. Matušů & R. Prokop. Control of systems with time-varying delay: A comparison study. *12th WSEAS International Conference on Automatic Control, Modelling and Simulation, ACMOS '10* , 2010, pp. 125-130.